

PATHOGENESIS OF AIDS

how does HIV cause AIDS?

Neal Nathanson, MD

Emeritus Professor

Department of Microbiology

University of Pennsylvania

School of Medicine

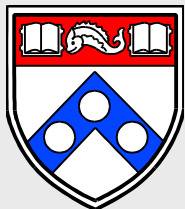

PATHOGENESIS OF AIDS

how does HIV cause AIDS?

- **Definitions**
- **Structure of HIV**
- **HIV entry and cell tropism**
- **HIV-cell interactions**
- **Course of HIV infection and AIDS**
- **HIV variants during infection**
- **HIV persistence**
- **How does HIV cause immunodeficiency?**

PATHOGENESIS OF AIDS

how does HIV cause AIDS?

DEFINITIONS

- **HIV: human immunodeficiency virus**
HIV is a member of the lentivirus family, a subgroup of retroviruses, RNA viruses that replicate via a DNA intermediate
- **AIDS: acquired immunodeficiency syndrome**
AIDS is defined by a loss of CD4 T lymphocytes or the occurrence of opportunistic infections or cancers

PATHOGENESIS OF AIDS

how does HIV cause AIDS?

STRUCTURE OF HIV

PATHOGENESIS OF AIDS

how does HIV cause AIDS?

A diagram of the virus particle to show the internal structure (after Brooks et al, 1998)

**VIRUS SPIKE
CONSISTING OF
TWO ENVELOPE PROTEINS
gp120 and gp 41**

**VIRUS ENVELOPE
(LIPID BILAYER)**

**VIRUS CAPSID
CONTAINING THE
RNA GENOME**

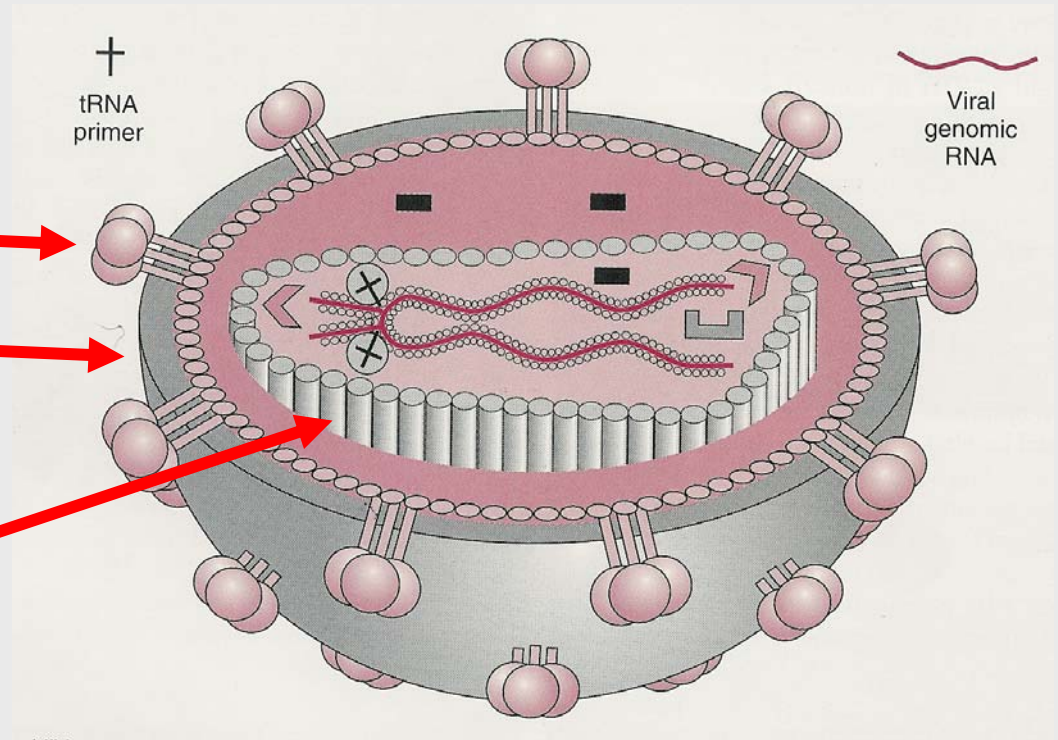

PATHOGENESIS OF AIDS

how does HIV cause AIDS?

The genes of HIV in the virion (RNA) and integrated into host cell genome (DNA)

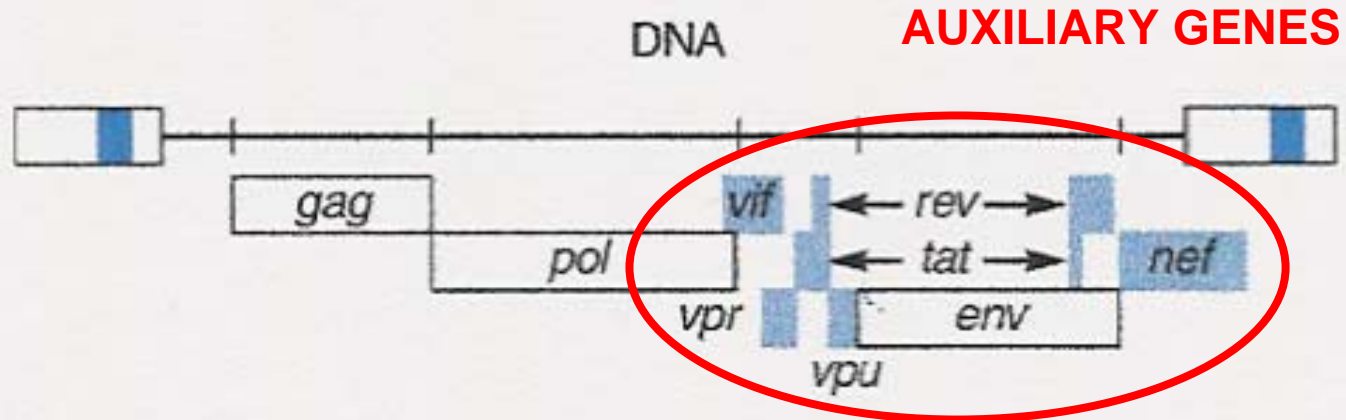

STRUCTURAL GENES

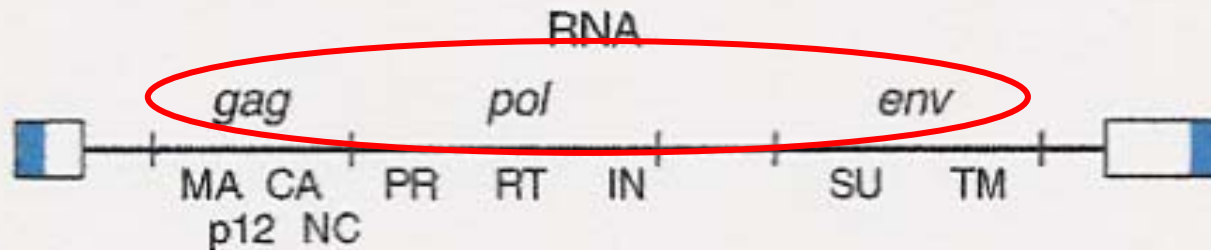

PATHOGENESIS OF AIDS

how does HIV cause AIDS?

HIV ENTRY INTO CELLS AND CELL TROPISM

PATHOGENESIS OF AIDS

how does HIV cause AIDS?

HIV attaches to cells in two steps

STEP 1 HIV attaches to its primary receptor, CD4

STEP 2 HIV attaches to a co-receptor, either CCR5 or CXCR4

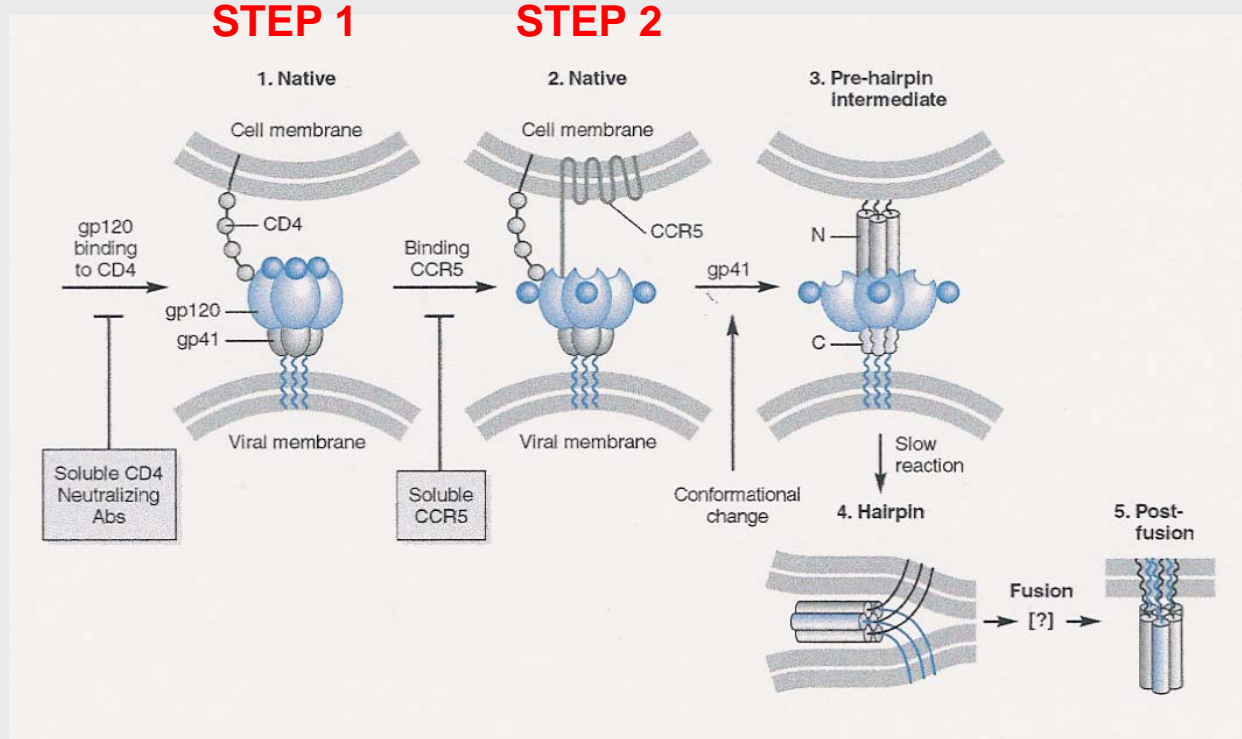

PATHOGENESIS OF AIDS

how does HIV cause AIDS?

HIV infects cells that carry the receptor and co-receptor

CD4 Expressed on the surface of CD4 T lymphocytes (helper T lymphocytes) and macrophages (including dendritic cells)

CCR5 Expressed on CD4+ T lymphocytes and on macrophages

CXCR4 Expressed on CD4+ T lymphocytes and T cell lines

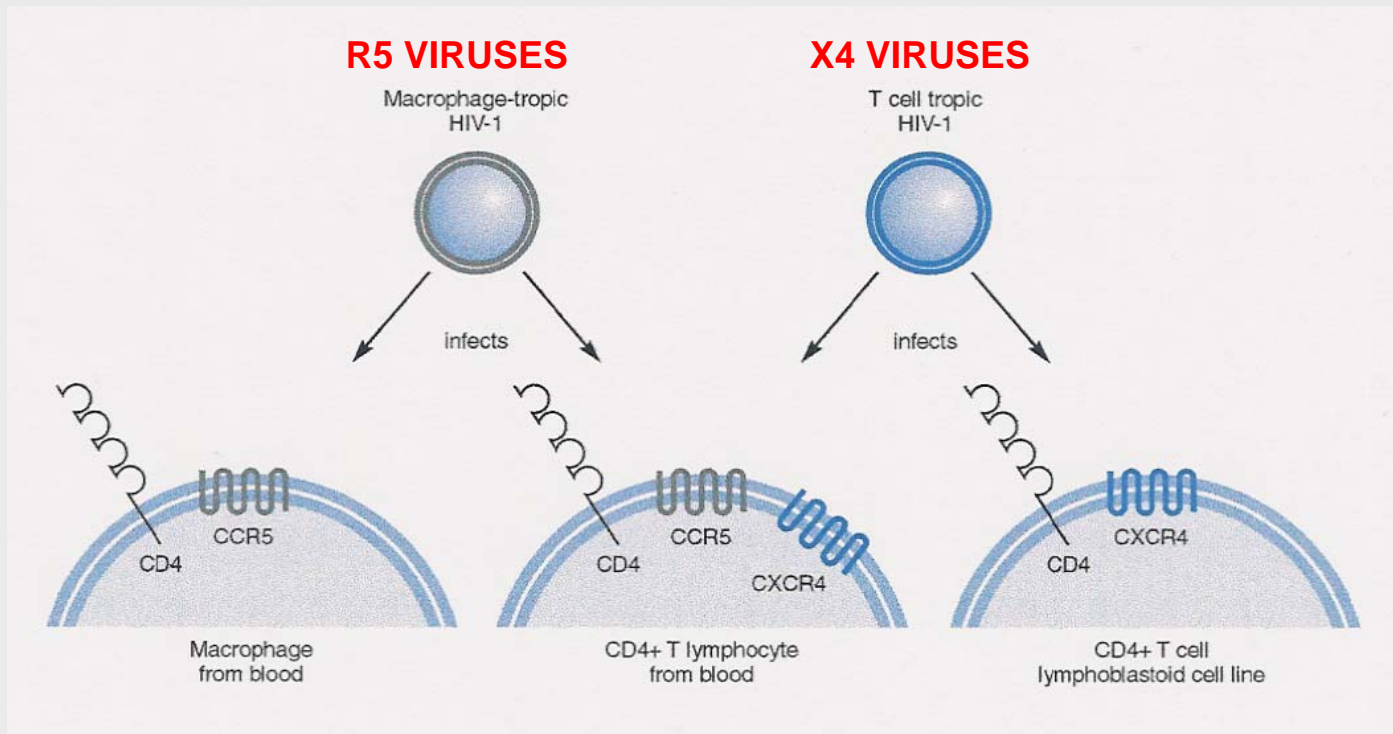

PATHOGENESIS OF AIDS

how does HIV cause AIDS?

HIV-CELL INTERACTIONS

PATHOGENESIS OF AIDS

how does HIV cause AIDS?

HIV infection of cultured cells shows (Collman, 1989)

both R5 and X4 viruses infect and kill CD4 T lymphocytes

Only R5 viruses infect macrophages and they are not killed

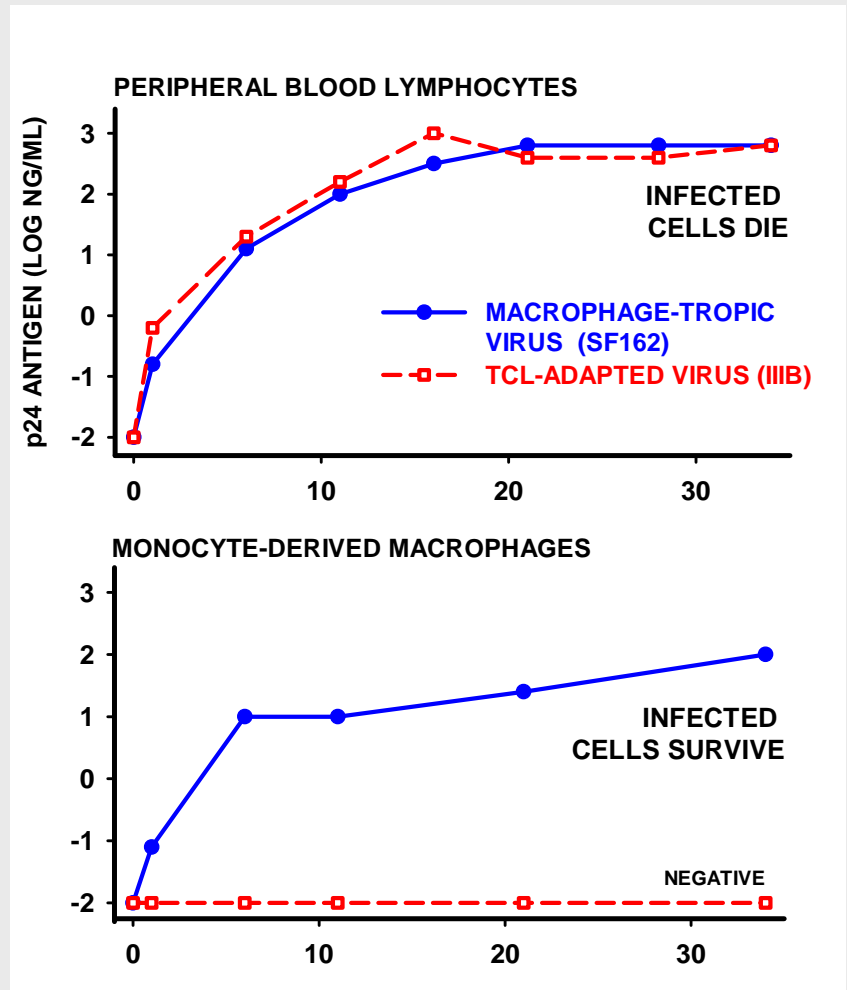

PATHOGENESIS OF AIDS

how does HIV cause AIDS?

COURSE OF HIV INFECTION AND AIDS

PATHOGENESIS OF AIDS

how does HIV cause AIDS?

HOW HIV INITIATES HETEROSEXUAL INFECTION (Shattock, 2003)

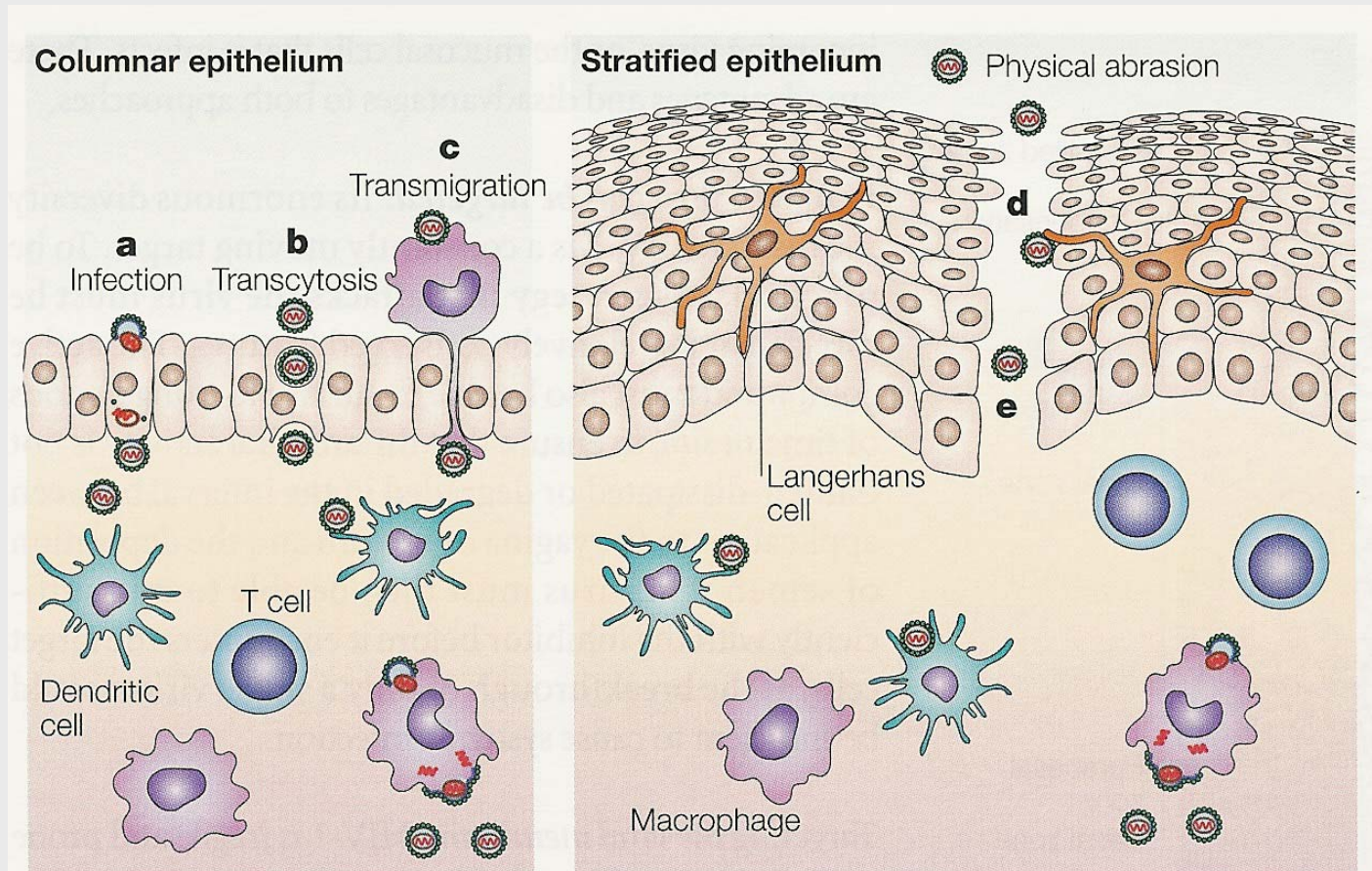

PATHOGENESIS OF AIDS

how does HIV cause AIDS?

THE COURSE OF HIV INFECTION AND AIDS (After Fauci, 1993)

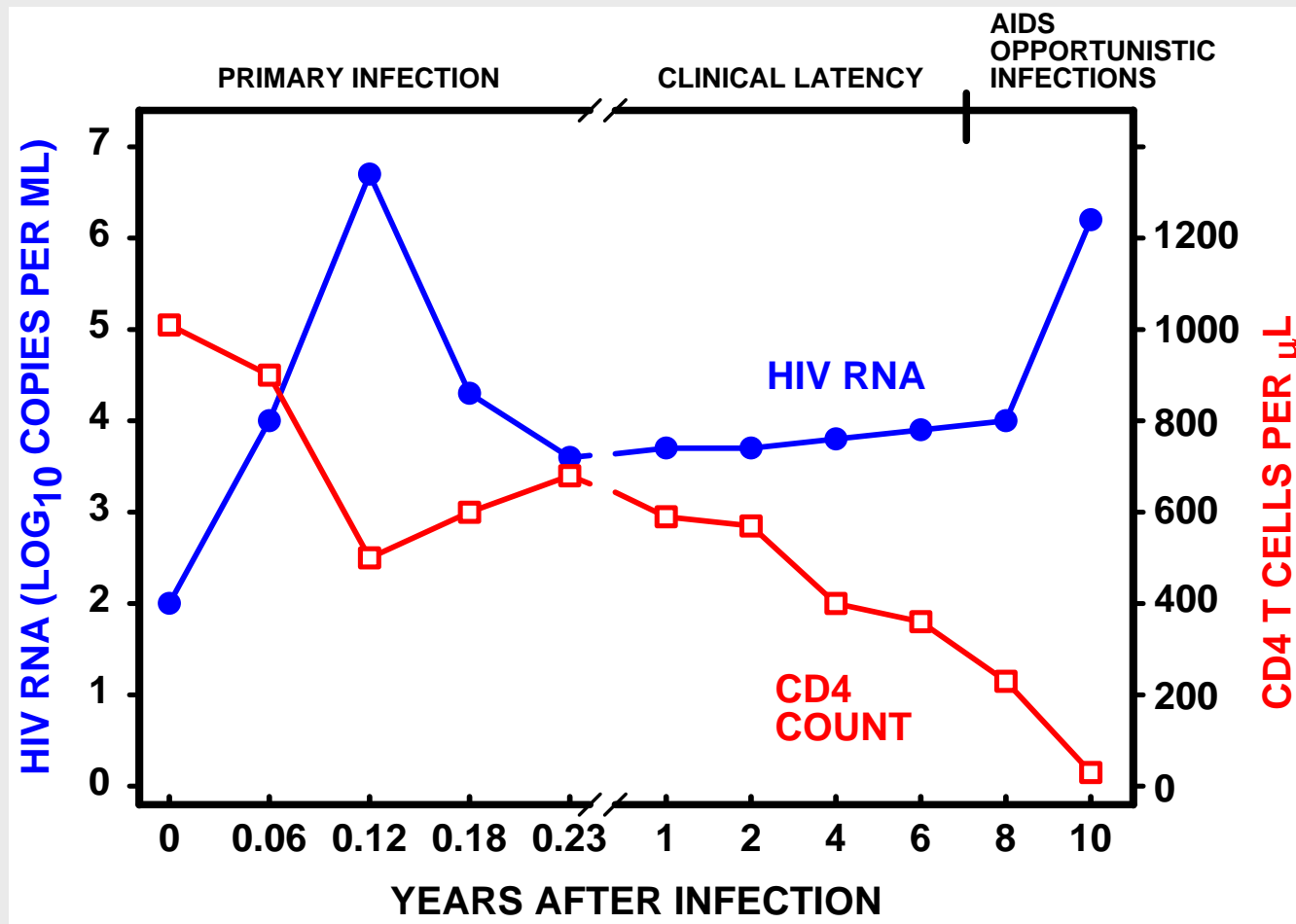

PATHOGENESIS OF AIDS

how does HIV cause AIDS?

HIV VIREMIA BY STAGE OF HIV INFECTION (Bagasra, 1993; Pan, 1993)

STAGE OF INFECTION	CD4 CELL COUNT	PLASMA HIV (TCID PER ML)	% CD4+ CELLS INFECTED
ASYMPTOMATIC	>500	100	3%
GENERAL LYMPHADENOPATHY	300-499	200	20%
	200-299	400	
CLINICAL AIDS	<200	1,500	30%

PATHOGENESIS OF AIDS

how does HIV cause AIDS?

HIV VARIANTS DURING INFECTION

PATHOGENESIS OF AIDS

how does HIV cause AIDS?

VIRUS VARIATION IS OFTEN SEEN DURING THE COURSE OF HIV INFECTION

BIOLOGICAL PHENOTYPE	VIRUS ISOLATED FROM PATIENTS WITH	
	ASYMPTOMATIC EARLY INFECTION	AIDS
REPLICATION KINETICS	SLOW/LOW	HIGH/RAPID
SYNCYTIUM INDUCTION	NON SI	SI
CELLULAR HOST RANGE	DUO-TROPIC	T CELL-TROPIC
CO-RECEPTOR USAGE	R5	X4

PATHOGENESIS OF AIDS

how does HIV cause AIDS?

DIFFERENTIAL INFECTION OF MONKEYS BY CO-RECEPTOR USAGE (Harouse, 1999)

**MACROPHAGE-TROPIC (R5) SHIV
INFECTS GUT-ASSOCIATED
LYMPHOID TISSUE PREFERENTIALLY
WITH MODEST REDUCTION OF CD4
CELLS IN CIRCULATION**

**T CELL-TROPIC (X5) SHIV INFECTS
LYMPH NODES PREFERENTIALLY
WITH SEVERE REDUCTION OF
CIRCULATING CD4 CELLS**

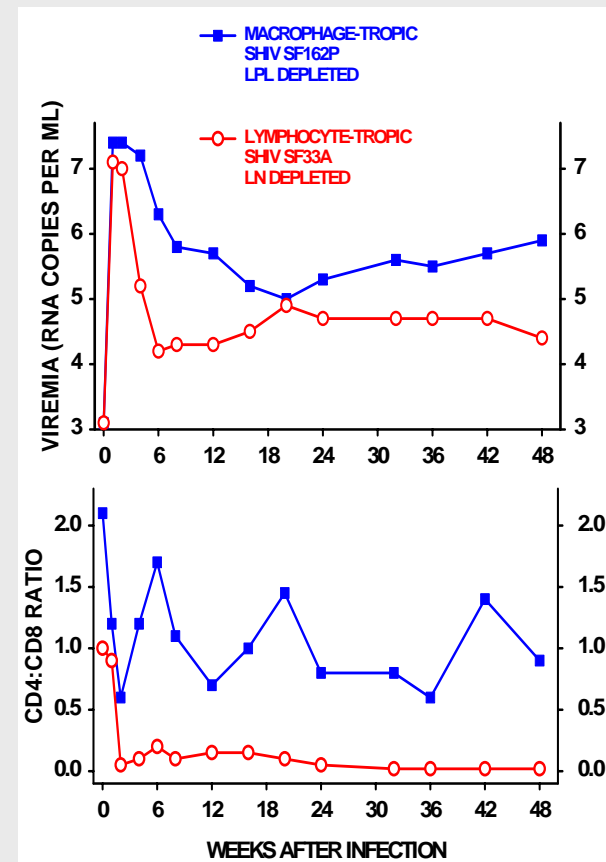

PATHOGENESIS OF AIDS

how does HIV cause AIDS?

HIV PERSISTENCE

PATHOGENESIS OF AIDS

how does HIV cause AIDS?

HIV INFECTION IN VIVO INCLUDES (Ho, 1999)

- Replication in activated T lymphocytes (1)
- Replication in macrophages (2)
- Latency in resting lymphocytes (3)

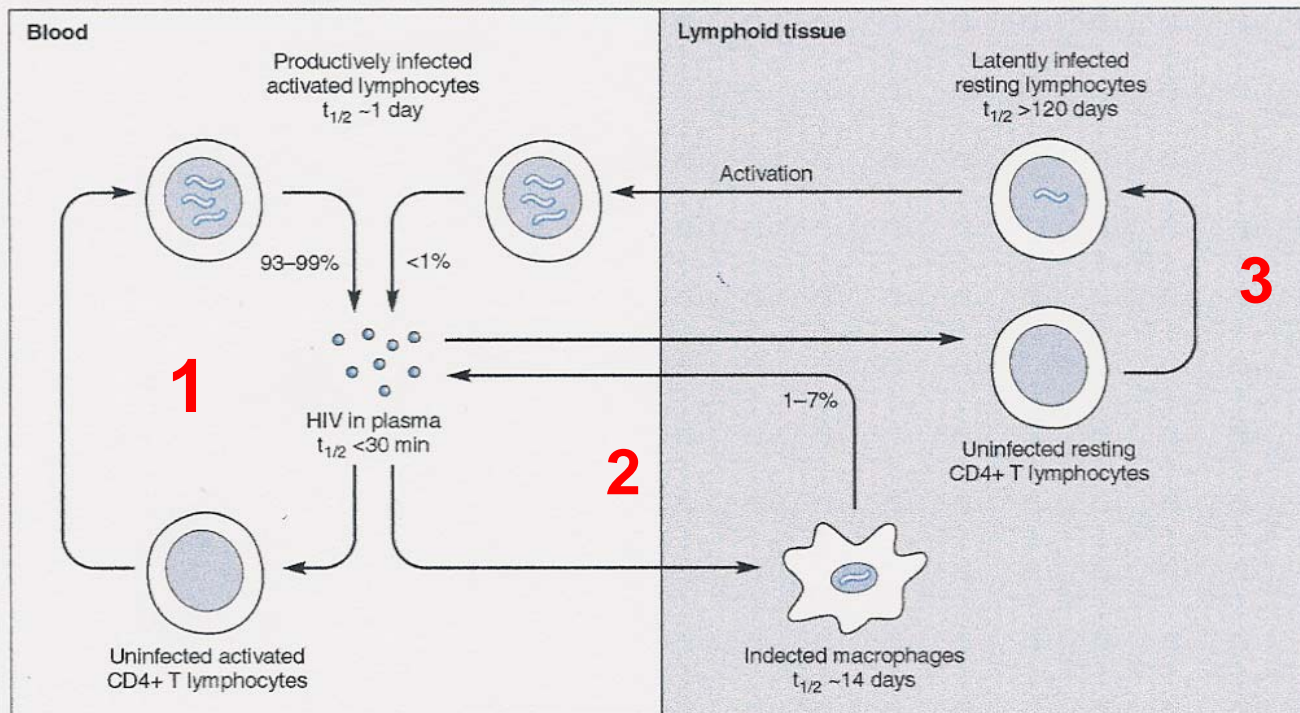

PATHOGENESIS OF AIDS

how does HIV cause AIDS?

ANTI-RETROVIRAL TREATMENT REFLECTS THE THREE HIV IN VIVO INFECTION CYCLES
(Mittler, 1999; and others)

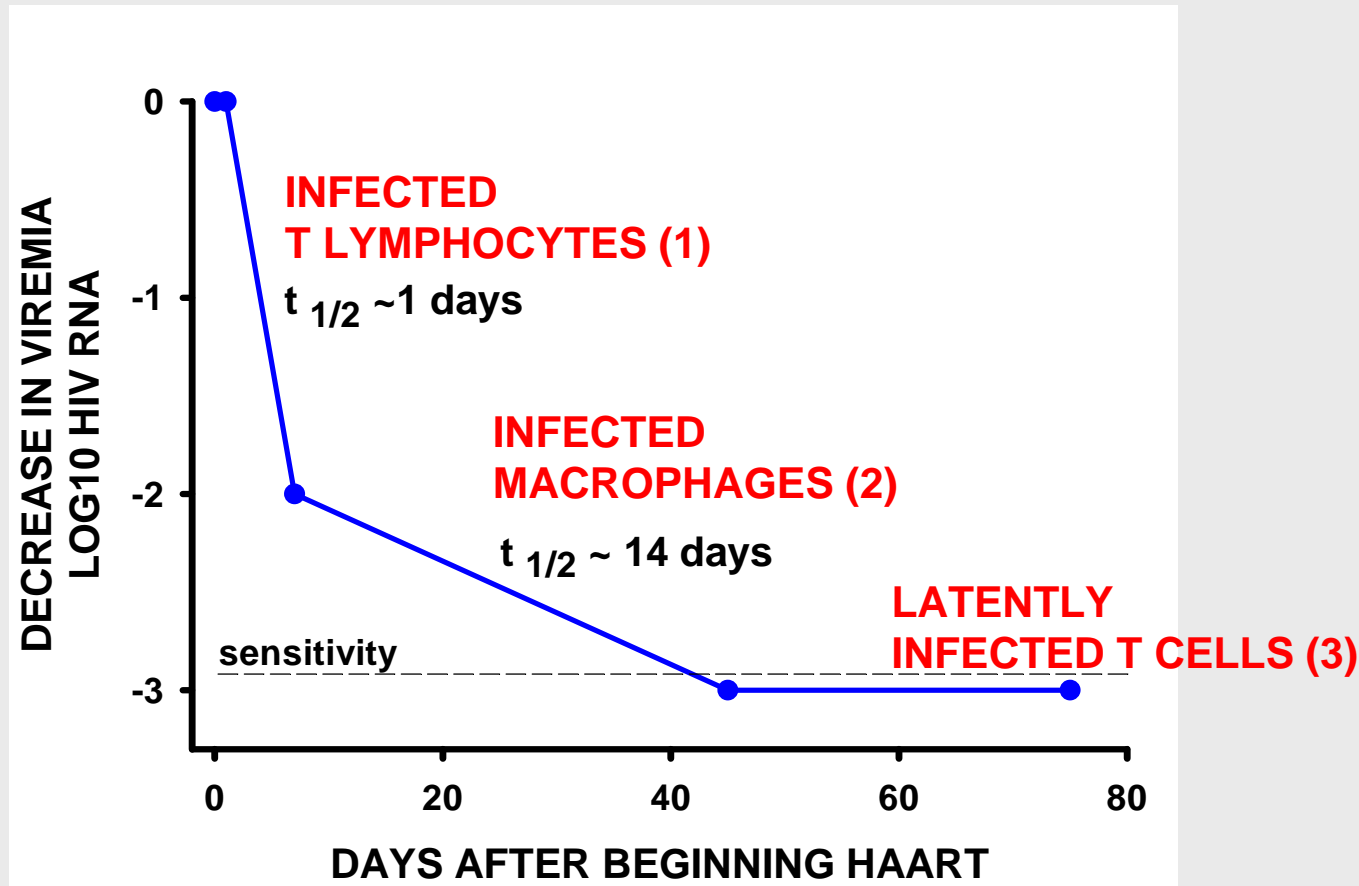

PATHOGENESIS OF AIDS

how does HIV cause AIDS?

**HOW DOES HIV CAUSE
IMMUNODEFICIENCY?**

PATHOGENESIS OF AIDS

how does HIV cause AIDS?

CD4 AND CD8 T LYMPHOCYTES: A CENTRAL PARADOX IN THE PATHOGENESIS OF AIDS

- **Opportunistic infections are mainly due to the activation of existing latent infections**
- **Control of latent infections is mediated by parasite-specific CD8 effector T lymphocytes, which are NOT the direct target of HIV**
- **Indirect mechanisms must be responsible for the depletion of effector CD8 cells, including**
 - ∞ **Hyperactivation of T cells leading to apoptosis and premature cell death**

PATHOGENESIS OF AIDS

how does HIV cause AIDS?

Still an enigma?



📌 PICTURE OF HEALTH? *This 15-year-old mangabey at the Yerkes National Primate Research Center in Atlanta has been SIV-infected for at least 10 years.*

FINIS